

AKVWL8: WALL LOUVER, VENTILATION, 8"

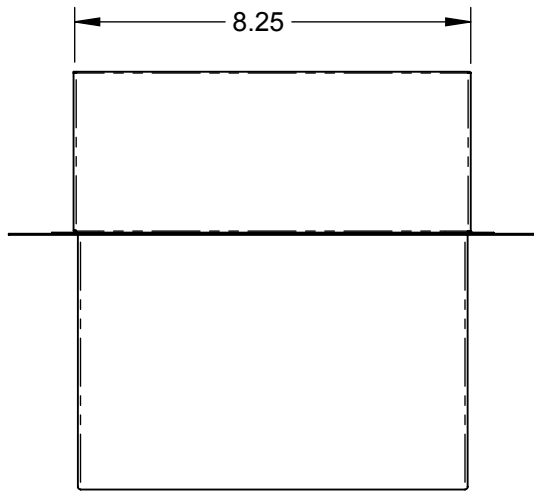

TOP VIEW

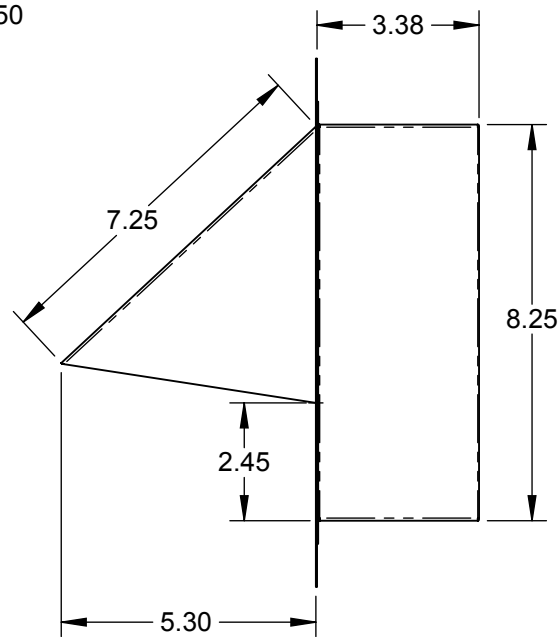
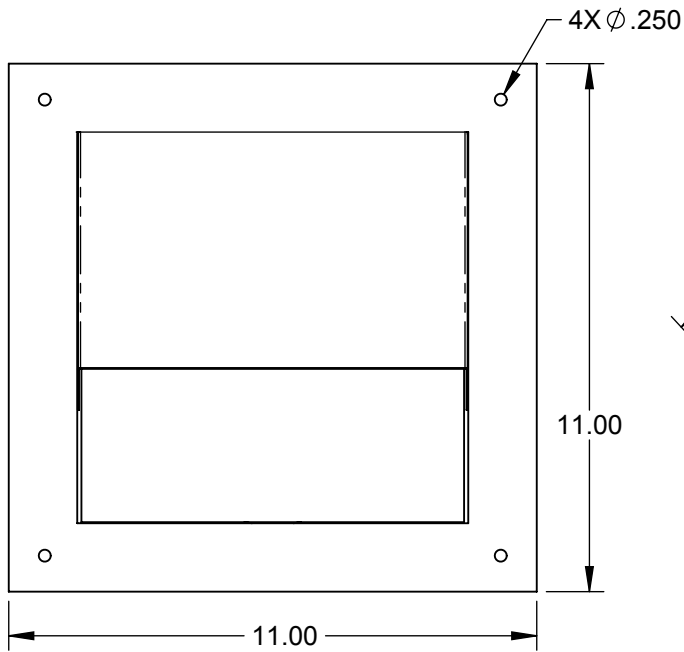
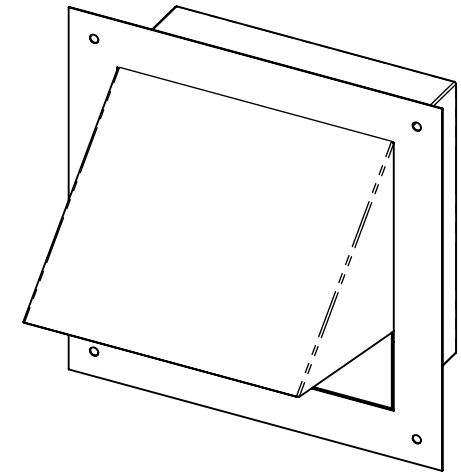

Ø8" HOLE
FOR ROUND
DUCT

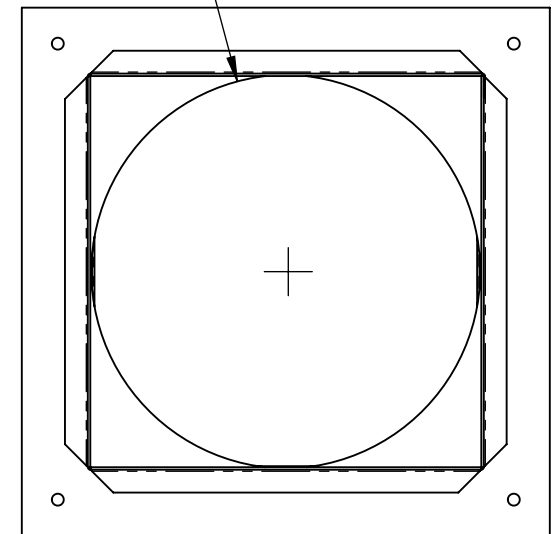

REAR VIEW