

KFCL30: 30" FREEZER COLUMN, LEFT HINGED

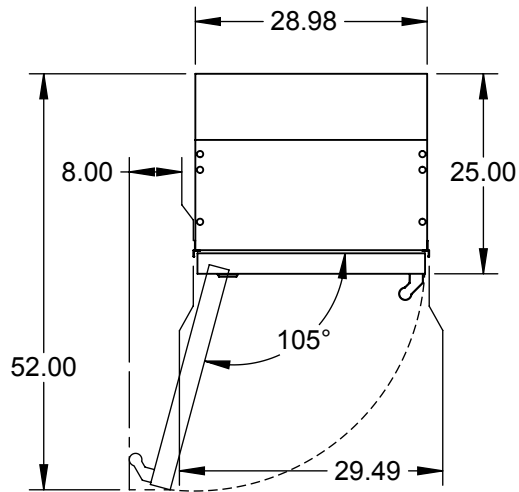

NOTE: A 90° DOOR OPENING IS SUFFICIENT TO ALLOW FULL EXTRACTION OF THE INNER DRAWERS, EVEN IF THE APPLIANCE IS DIRECTLY ADJACENT TO A WALL. HOWEVER IF 105° OPENING IS DESIRED, THEN POSITION APPLIANCE AT 8" DISTANCE SHOWN.

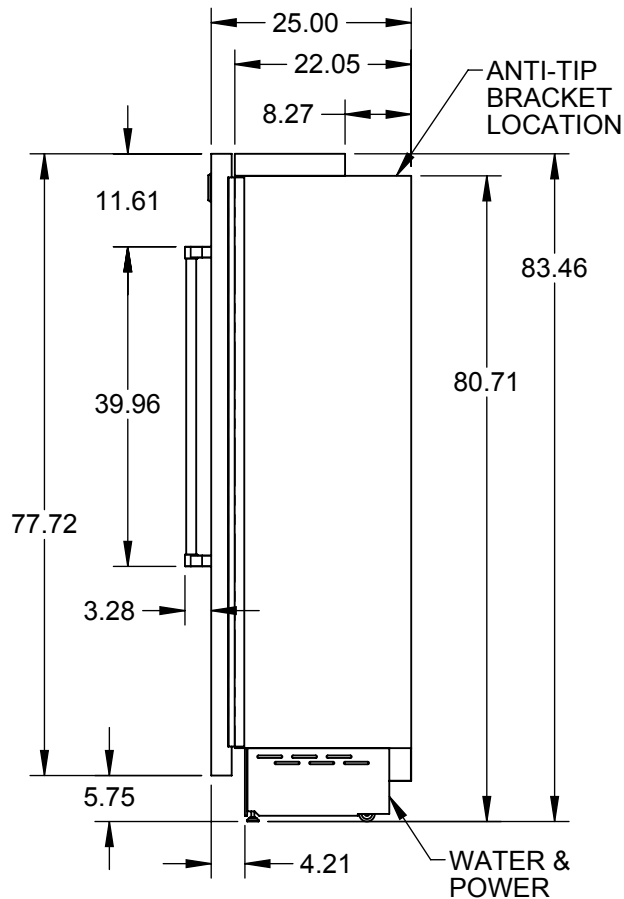
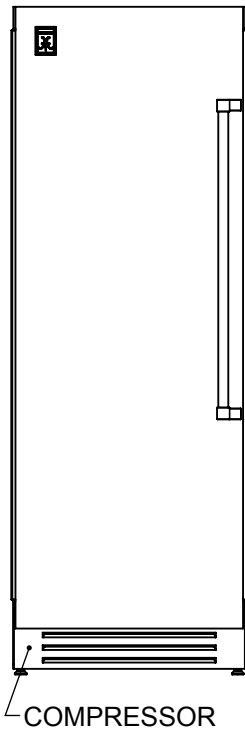
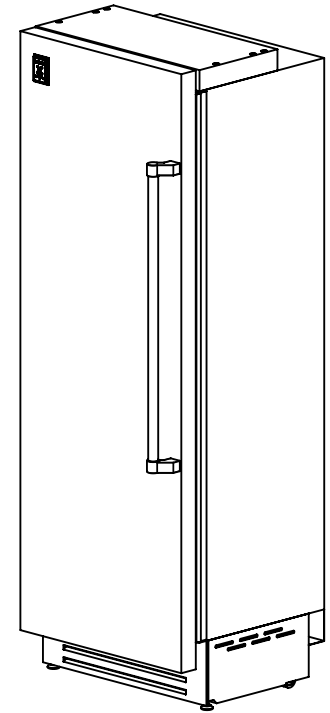

CUTOUT REQUIREMENTS: 30W X 84H X 25D

SPECIFICATIONS:

FRIDGE CAPACITY: n/a
 FREEZER CAPACITY: 16.87 FT³
 BOTTLE CAPACITY: n/a
 VOLTAGE: 115V - 60Hz
 CURRENT: 3.0A
 ENERGY USE: 598 kWh/yr
 REFRIGERANT: R134a
 FRIDGE GAS FILL: n/a
 FREEZER GAS FILL: 6.3 oz
 WEIGHT: 419 LBS.