

KVDC3024: DUCT COVER, VENTILATION, 30W X 24H

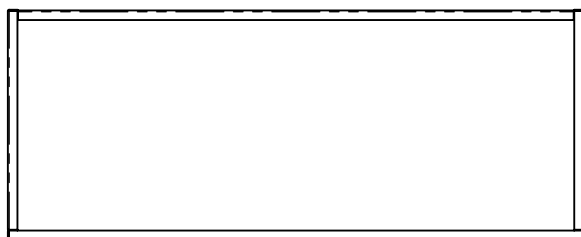

TOP VIEW

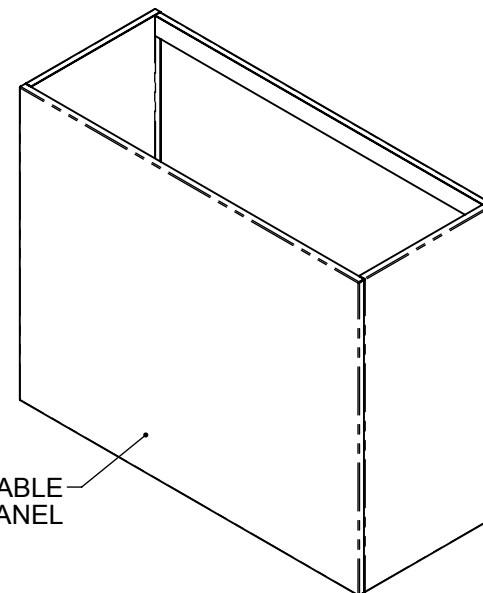

REMOVABLE
FRONT PANEL

